

Uniden®

**QUICK
EASY
STEPS**

**FOR SETTING
UP YOUR CB!**

PC78 ELITE

Bearcat®

EASILY REGISTER
THIS PRODUCT
ONLINE AT
www.uniden.com



Contents

Description.....	1
Elimination of Licensing.....	1
Emergency Operation	1
Controls and Functions	2
Installation.....	4
Mobile Station Installation.....	4
Mobile Station Antenna	4
Marine Installation	4
Connecting the Power Cords.....	5
Ground Information	5
Negative Ground System.....	5
Positive Ground System.....	5
To Receive	6
Weather Information	7
To Transmit.....	8
Multi-Function Meter.....	8
Preventive Maintenance	9
Maintenance.....	9
Troubleshooting.....	10
Servicing Your Transceiver	10
Radio Code Definitions.....	11
Specifications	12
Two-Year Extended Warranty.....	13

Unpacking

Carefully unpack your **PC78 Elite** and check the contents against this list:

- **PC78 Elite** CB 2-way mobile radio
- Microphone
- Mounting Bracket Kit
- DC Power Cord
- Reference Guide
- Part 95 Subpart D (FCC Rules)
- Product Registration Card

If any items are missing or damaged, contact your place of purchase immediately.

***Please be sure to complete and mail your
Product Registration Card.***

Description

Your Uniden **PC78 Elite** represents the highest quality communications device designed for use in the Citizens Band Radio Service. It will operate on any of the 40 AM frequencies authorized by the Federal Communications Commission (FCC).



The Citizens Band Radio Service is under the jurisdiction of the Federal Communications Commission (FCC). Any adjustments or alterations which would alter the performance of the transceiver's original FCC certification, or which would change the frequency determining method, are strictly prohibited. Replacement or substitution of crystal, transistors, ICs, regulator diodes, or any other part of a unique nature, with parts other than those recommend by Uniden, may cause violations of the technical regulations in Part 95 of the FCC Rules or in violation of certification requirements in Part 2 of the rules.

Elimination of Licensing

The FCC has ruled that CB Radio Service operators are no longer required to obtain an FCC License to operate their CB equipment. In doing so, the FCC also decided to permit CB station operation without station identification.

Elimination of individual station licenses does not reduce the operating privileges or responsibilities of CB users. An operator of a CB radio station is still required to comply with the Communications Act and with the rules of Citizens Band Radio Service.

Uniden is a registered trademark of Uniden America Corporation.



Features, Specifications, and availability of Optional Accessories are subject to change without notice.

Emergency Operation

1. Set the switch to **CH9** or turn **Channel Selector** knob to Channel 9.
2. Press the microphone **PTT** switch and speak clearly.
3. If there is no response, select an active channel and ask that party to relay your emergency broadcast on Channel 9.



All channels, except Channel 9 may be used for normal communication. Channel 9 is reserved by the FCC for emergency communication involving the immediate safety of individuals or protection of property. Channel 9 may also be used to render assistance to a motorist.

This is an FCC rule and applies to all operators of CB radios.

Controls and Functions

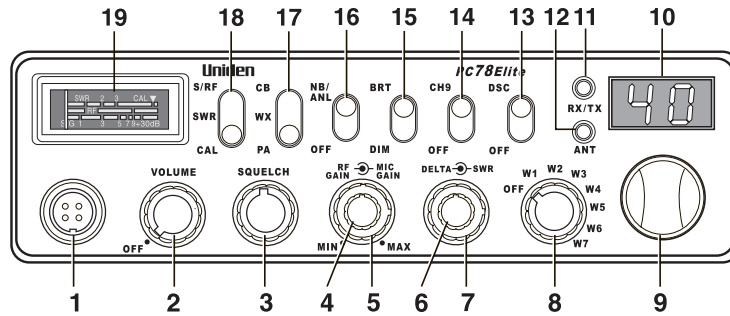

FRONT VIEW - PC78 Elite BACKLITTED PANEL

1. **Microphone Jack**
2. **ON OFF - VOLUME:** Turns radio on or off; adjusts speaker volume.
3. **SQUELCH:** Reduces background noise when there is no incoming signal.
4. **RF GAIN:** Improves reception in strong signal areas.
5. **MIC GAIN:** Adjusts microphone sensitivity.
6. **DELTA TUNE:** Fine tunes the receiver.
7. **SWR:** Calibrates the meter for Standing Wave Ratio (**SWR**) measurements.
8. **Weather Channel** Knob: Selects weather channel.
9. **Channel** Knob: Selects channel.
10. **Channel Display:** Displays current channel selection.
11. **RX/TX** Indicator: **Red**-transmitting; **green**-receiving.
12. **ANT:** Indicates a high SWR condition in antenna system. Check antenna, cable and connections.
13. **Dynamic Squelch Control (DSC):** Automatically sets Squelch to optimal level for stronger signals.
14. **CH9/OFF:** Turns Channel 9 on or off.
15. **BRT/DIM:** Adjusts the brightness of LED.
16. **NB/ANL:** Reduces external noise and interference from vehicle ignition systems.

17. **CB/WX/PA**: Selects **PA** (Public Address) **WX** (Weather Radio) or **CB**.



*Do not use **PA** function unless an external speaker is connected.*

18. **S/RF/SWR/ CAL**: Selects meter function. **S/RF**- normal; **SWR** and **CAL** are for **SWR** measurements only. See page 8 for calibration procedures.
19. **Multi-function Meter**: Measures **SWR**, **RF** and **S** signal strength.

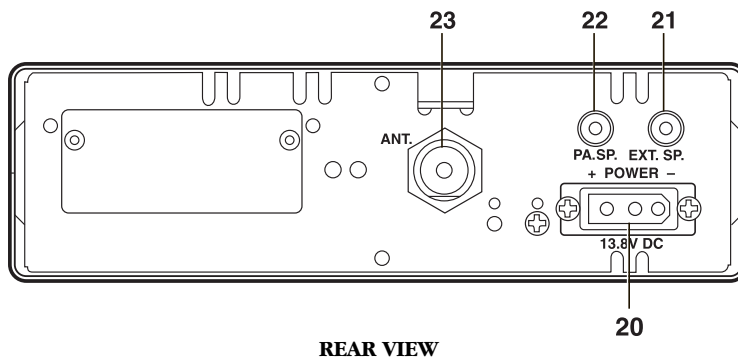

REAR VIEW

20. **POWER**: Connects DC power to transceiver.
21. **EXT. SP.**: Connects optional 8-ohm 4-watt speaker to remotely monitor receiver.



When the external speaker is plugged in, the internal speaker is off.

22. **PA SP.**: Connects external 8-ohm, 4-watt speaker.



*To prevent acoustic feedback, separate the microphone from the speaker when operating the **PA** at high output levels.*

23. **ANT.**: Connects antenna cable to transceiver.

Installation

MOBILE STATION INSTALLATION



Plan the location of the transceiver and microphone bracket before beginning installation.

1. Select a location that is convenient for operating the radio, but does not interfere with the driver or passenger.
2. Install bracket with self-tapping screws provided.
3. Connect wiring. (See instructions for Connecting the Power Cords.)
4. Attach the microphone bracket to the side of the radio.
5. Attach radio to bracket.

MOBILE STATION ANTENNA

Because the maximum power output of the transmitter is limited by the FCC, the quality of your antenna is very important. To achieve the maximum transmission distance, we strongly recommend that you install only a high quality antenna. You have just purchased a superior transceiver - don't diminish its performance by installing an inferior antenna.

Only a properly matched antenna system will allow maximum power transfer from the 50 ohm transmission line to the radiating element. Your **Uniden** dealer is qualified to help you select the proper antenna for your requirements. A whip style antenna may be used for automobile installation.

A short 'loaded' whip antenna is easier to install on an automobile. However, the efficiency of the short whip antenna is less than that of a full quarter-wave whip antenna.



MARINE INSTALLATION

Consult your dealer for information regarding marine installation. It is important to adequately ground the system and to prevent electrolysis between the fittings in the hull and the water.

CONNECTING THE POWER CORDS

We recommend connecting the power lead to the Ignition Switch Accessory Terminal. This way, the transceiver is automatically turned off when the ignition switch is turned off.

Or, the power cord may be connected to an available terminal on the fuse block, or to a point in the wiring harness. However, caution must be taken to prevent a short circuit. If in doubt, contact your vehicle dealer for information.



This transceiver may be installed and used in any 12-volt DC negative or positive ground system vehicle.

GROUND INFORMATION

Most newer U.S. and foreign made cars, and small trucks, use a negative ground system. Some older cars, and some new large trucks, use a positive ground system.

With a negative ground system, the negative (-) battery terminal is usually connected to the vehicle motor block. If you cannot determine the polarity system of your vehicle, contact your vehicle dealer for information.

Negative Ground System

If you have a negative ground system, connect the **red** DC power cord from the transceiver to the positive (+) battery terminal or other convenient point. Then connect the **black** power cord to the vehicle chassis or negative (-) battery terminal.

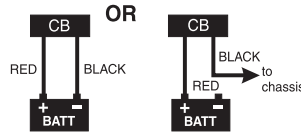

Positive Ground System

If you have a positive ground system, connect the **black** DC power cord from the transceiver to the negative (-) battery terminal or other convenient point. Then, connect the **red** power cord to the vehicle chassis or the positive (+) battery terminal.

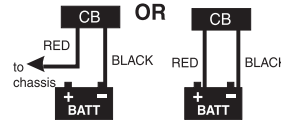

To Receive

NOTE

Be sure that the power source, antenna, and microphone are properly connected before proceeding.

1. Turn unit **ON** and set **VOLUME** Control to a comfortable level.

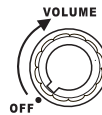

2. Select **CHANNEL**.



3. Set switch to **NB/ANL**.



Dynamic Squelch Control automatically sets Squelch to the optimal level for stronger transmission and signal clarity. To scan for weaker signals, turn **Dynamic Squelch Control** off and perform the following steps:

- 4a. Turn **SQUELCH** fully clockwise so only strong signals can get through.

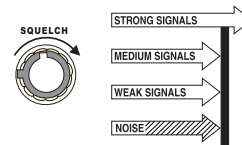

- 4b. Turn **SQUELCH** fully counter clockwise until you hear a hiss. Everything gets through - noise, weak signals, and strong signals.

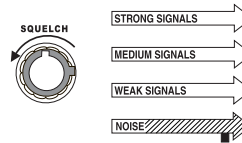

- 4c. Turn **SQUELCH** back clockwise until the hiss stops. Only clearer signals get through.

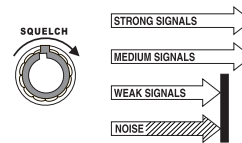



Set **SQUELCH** only when the radio is not receiving a strong signal.

- Adjust **RF GAIN** knob (small) to optimize reception in strong signal areas.
- Adjust **DELTA** knob (small) to reduce or eliminate adjacent channel interference.
- Set meter switch to **S/RF**.

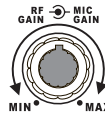

Weather Information

Your **PC78 Elite** combines a **CB Radio** with a **Weather Radio** and a **Weather Alert System**. The Weather Radio continually broadcasts weather conditions. The Weather Alert System sounds a seven-second signal in the event of severe weather.

To configure your CB radio to receive weather alerts while using your CB radio:

- Set the switch to **WX**.
- Turn the **Weather Channel** knob to the channel with best reception.

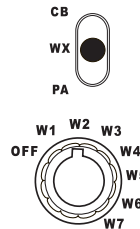

Left at this setting, you will hear only weather broadcasts and Weather Alert Signals.

To use your CB radio normally while monitoring for weather alerts, set the switch to **CB**.

When you hear a Weather Alert Signal, and desire to hear weather information, return the switch to **WX**.



To Transmit



Perform a voltage Standing Wave Ratio (**SWR**) measurement prior to using the transmitter. A **SWR** ratio in excess of 2:1 may damage the transmitter.



Be sure to read and understand Part 95, FCC Rules and Regulations before operating your transmitter.

1. Select a channel.
2. Adjust **MIC GAIN**.
3. When the channel is clear, press the microphone **PTT** switch and speak.

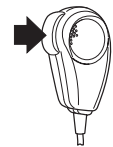

Multi-Function Meter

SWR Meter: Measures **SWR** (standing wave ratio) of antenna. Use to check antenna system or to adjust your antenna to the proper length.

To measure **SWR**:

1. Position meter switch to **CAL**.
2. Press and hold microphone **PTT** switch. (Transmit)
3. Calibrate meter with **SWR** knob by adjusting the needle to the ▼ mark.
4. Move the meter switch to the **SWR** position while pressing the microphone **PTT** switch.
5. Release the **PTT** switch.

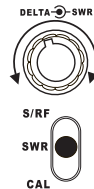
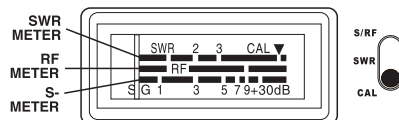

A reading following two is acceptable. Higher readings indicate a problem in the antenna system. Problems may be caused by humidity, vibration, or corrosion. Check both ends of the coaxial cable connector. Also check for damage to the cable or antenna.

RF Meter: Measures RF Output Power for transmitter. To use, position the meter switch at **S/RF**. Press microphone **PTT** switch to read transmitting power.

S-Meter: Measures incoming signal strength. To use, position the meter switch at **S/RF**. The meter swings to indicate signal strength. i.e. **S 3, S 5, S 7 . . .**

Preventive Maintenance

Every six months:

1. Check the Standing Wave Ratio (**SWR**).
2. Be sure all electrical connections are tight.
3. Inspect antenna coaxial cable for wear or breaks in shielding.
4. Be sure all screws and mounting hardware are tight.

Maintenance

The **PC78 Elite** is designed to give you years of trouble-free service. There are no user-serviceable parts inside. Except for the fuse in the DC power cord, no maintenance is required.

To replace a blown fuse:

1. Press ends of the fuse holder together. Twist to open. Carefully separate the two pieces.

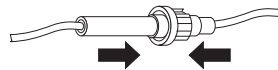

2. Remove the fuse and inspect. If blown, replace with the same type fuse.

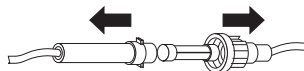

Use only the fuse specified for your **PC78 Elite**. Failure to do so may void your warranty.

Troubleshooting

Problem	Suggestion
Unit does not power up	<input type="checkbox"/> Check the ignition key position. <input type="checkbox"/> Check power cord connections. <input type="checkbox"/> Check fuse. <input type="checkbox"/> Check vehicle electrical system.
No reception	<input type="checkbox"/> Check microphone connection. <input type="checkbox"/> Set CB/WX/PA switch to CB . <input type="checkbox"/> Check VOLUME and SQUELCH . <input type="checkbox"/> Check antenna. <input type="checkbox"/> Check antenna connection. <input type="checkbox"/> Set RF GAIN to MAX .
Poor Reception	<input type="checkbox"/> Check VOLUME and SQUELCH . <input type="checkbox"/> Be sure antenna SWR is normal. <input type="checkbox"/> Set RF GAIN to MAX . <input type="checkbox"/> Check and adjust DELTA TUNE .
No Transmission	<input type="checkbox"/> Set CB/WX/PA switch to CB . <input type="checkbox"/> Check microphone connection. <input type="checkbox"/> Check MIC GAIN and adjust to MAX .
Low Transmission	<input type="checkbox"/> Be sure antenna SWR is normal. <input type="checkbox"/> Check MIC GAIN and adjust to MAX .

If you do not get satisfactory results after performing the above checks, call the **Uniden Customer Service Center** at 1-800-297-1023, 8:00 a.m. to 5:00 p.m. CST, Monday through Friday.

Servicing Your Transceiver

Technical information, diagrams, and charts are provided on request. It is the user's responsibility to see that this radio is operating at all times in accordance with the FCC Citizens Radio Service regulations. We highly recommend that you consult a qualified radio/telephone technician for servicing and aligning this CB radio product. Please read the Warning information on page 1 of this Guide.



When ordering parts, be sure to specify the correct model number and serial number of the unit.

Radio Code Definitions

The following list contains common "10-Codes" used by CB radio operators for faster communication and better understanding.

Code	Meaning	Code	Meaning
10-1	Received poorly	10-35	Confidential information
10-2	Receiving well	10-36	Correct time is
10-3	Stop transmitting	10-37	Wrecker needed at
10-4	OK, message received	10-38	Ambulance needed at
10-5	Relay message	10-39	Your message is delivered
10-6	Busy, stand by	10-41	Please turn to channel
10-7	Out of service, leaving air	10-42	Traffic accident at
10-8	In service, subject to call	10-43	Traffic tie up at
10-9	Repeat message	10-44	I have a message for you
10-10	Transmission completed, standing by	10-45	All units within range please report
10-11	Talking too rapidly	10-50	Break channel
10-12	Visitors present	10-60	What is next message number
10-13	Advise Weather/Road conditions	10-62	Unable to copy, use phone
10-16	Make pickup at	10-63	Net directed to
10-17	Urgent business	10-64	Net clear
10-18	Anything for us?	10-65	Awaiting your next message/assignment
10-19	Nothing for you, return to base	10-67	All units comply
10-20	My location is	10-70	Fire at
10-21	Call by telephone	10-71	Proceed with transmission in sequence
10-22	Report in person to	10-77	Negative contact
10-23	Stand by	10-81	Reserve hotel room for
10-24	Completed last assignment	10-82	Reserve room for
10-25	Can you contact	10-84	My telephone number is
10-26	Disregard last information	10-85	My address is
10-27	I am moving to channel	10-91	Talk closer to microphone
10-28	Identify your station	10-93	Check my frequency on this channel
10-29	Time is up for contact	10-94	Please give me a long count
10-30	Does not conform to FCC rules	10-99	Mission completed, all units secure
10-32	I will give you a radio check	10-200	Police needed at
10-33	EMERGENCY TRAFFIC		
10-34	Trouble at this station		

Specifications

General

Channels:	40
CB Frequency Range:	26.965 to 27.405 MHz
Weather Frequency Range:	162.400MHz (WX CH1) 162.425MHz (WX CH2) 162.450MHz (WX CH3) 162.475MHz (WX CH4) 162.500MHz (WX CH5) 162.525MHz (WX CH6) 162.550MHz (WX CH7)
Frequency Control:	Phase Locked Loop (PLL) synthesizer
Frequency Tolerance:	±0.002%
Operating Temperature:	-30° C to +60° C (CB) -10° C to +60° C (WX) -10° C to +60° C (DSC on)
Microphone:	Plug-in type; 600 ohms dynamic
Input Voltage:	13.8 VDC nominal (positive or negative ground)
Current Drain:	TX: AM full modulation, 2.2 A (max.) RX: Squelched, 0.4 A; with maximum audio output, 1.2A (nominal)
Size:	7-9/32" W x 8-57/64" D x 2-13/64" H
Weight:	4 lbs. 3 oz. with microphone
Antenna Connector:	UHF, SQ-239
Meter:	Illuminated; indicates relative power output and received signal strength SWR.

Transmitter

Power Output:	4 watts
Modulation:	High- and low-level, Class B amplitude modulation
Frequency Response:	300 to 3000 Hz
Output Impedance:	50 ohm, unbalanced

Receiver

Sensitivity:	Less than 1 µV for 10 dB, (S+N)/N
Selectivity:	6 dB @ 7 kHz, 60 dB; @10 kHz
Image Rejection:	80 dB typical
Adjacent-Ch. Rejection:	60 dB typical
IF Frequencies: Double Conversion:	1st: 10,695 MHz; 2nd: 455 kHz
Automatic Gain Control (AGC):	Less than 10 dB change in audio output for inputs from 10 to 50,000 µV
RF Gain Control:	Adjustable for optimum signal reception
Delta Tune Range:	±1.5 kHz, continuously adjustable
Noise Blanker:	RF type
Squelch:	Adjustable; threshold less than 1 µV
Audio Output Power:	4 watts
Frequency Response:	300 to 3000 Hz
Distortion:	Less than 7% at 3 watts, 1000 Hz
Internal Speaker:	16 ohms, round
External Speaker:	8 ohms, disables internal speaker when connected

PA System

Power Output:	4 watts into external speaker
External Speaker for PA speaker:	8 ohms when CB/PA switch is in PA. The PA also monitors the receiver; separate jack provided.

Specifications shown are typical and subject to change without notification.

Two-Year Extended Warranty

Important: Evidence of original purchase is required for warranty service.

WARRANTOR: UNIDEN AMERICA CORPORATION ("Uniden")

ELEMENTS OF WARRANTY: Uniden warrants, for two years, to the original retail owner, this Uniden Product to be free from defects in materials and craftsmanship with only the limitations or exclusions set out below.

WARRANTY DURATION: This warranty to the original user shall terminate and be of no further effect two years after the date of original retail sale. The warranty is invalid if the Product is (A) damaged or not maintained as reasonable or necessary, (B) modified, altered, or used as part of any conversion kits, subassemblies, or any configurations not sold by Uniden, (C) improperly installed, (D) serviced or repaired by someone other than an authorized Uniden service center for a defect or malfunction covered by this warranty, (E) used in any conjunction with equipment or parts or as part of any system not manufactured by Uniden, or (F) installed or programmed by anyone other than as detailed by the owner's manual for this product.

STATEMENT OF REMEDY: In the event that the product does not conform to this warranty at any time while this warranty is in effect, warrantor will either, at its option, repair or replace the defective unit and return it to you without charge for parts, service, or any other cost (except shipping and handling) incurred by warrantor or its representatives in connection with the performance of this warranty. Warrantor, at its option, may replace the unit with a new or refurbished unit. THE LIMITED WARRANTY SET FORTH ABOVE IS THE SOLE AND ENTIRE WARRANTY PERTAINING TO THE PRODUCT AND IS IN LIEU OF AND EXCLUDES ALL OTHER WARRANTIES OF ANY NATURE WHATSOEVER, WHETHER EXPRESS, IMPLIED OR ARISING BY OPERATION OF LAW, INCLUDING, BUT NOT LIMITED TO ANY IMPLIED WARRANTIES OF MERCHANTABILITY OR FITNESS FOR A PARTICULAR PURPOSE. THIS WARRANTY DOES NOT COVER OR PROVIDE FOR THE REIMBURSEMENT OR PAYMENT OF INCIDENTAL OR CONSEQUENTIAL DAMAGES. Some states do not allow this exclusion or limitation of incidental or consequential damages so the above limitation or exclusion may not apply to you.

LEGAL REMEDIES: This warranty gives you specific legal rights, and you may also have other rights which vary from state to state. This warranty is void outside the United States of America.

PROCEDURE FOR OBTAINING PERFORMANCE OF WARRANTY: If, after following the instructions in the owner's manual you are certain that the Product is defective, pack the Product carefully (preferably in its original packaging). The Product should include all parts and accessories originally packaged with the Product. Include evidence of original purchase and a note describing the defect that has caused you to return it. The Product should be shipped freight prepaid, by traceable means, to warrantor at:

Uniden America Corporation

Parts and Service Division
4700 Amon Carter Blvd
Fort Worth, TX 76155
(800) 297-1023, 8 a.m. to 5 p.m., Central,
Monday through Friday

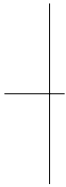

Uniden®

© Uniden America Corporation, Fort Worth, Texas.
Custom manufactured in China.

Contains additional foreign articles.

UTZZ01343FZ

